



Talon 1000R 3" Lift Installation Instructions

We have tried to cover every detail of this installation as thoroughly as possible, but in the event that we missed something, please let us know. We really appreciate your business, and we hold customer satisfaction with high regard. Do not hesitate to give me a call if you need clarification or assistance with anything at all throughout your installation process.

-Jared Doster
936-581-2948

Liability Statement

Texas Tough Customs LLC's products are designed to best fit user's ATV/UTV under stock conditions. Adding, modifying, or fabricating any factory or aftermarket parts will void any warranty provided by Texas Tough Customs LLC and is not recommended. Texas Tough Customs LLC's products could interfere with other aftermarket accessories. If user has aftermarket products on machine, contact Texas Tough Customs LLC to verify that they will work together.

Although Texas Tough Customs LLC has hundreds of satisfied customers, users should be aware that installing lift kits, long travel, or suspension kits, tires, etc. will change the ride of machine and may increase maintenance and part wear. Operating any off-road machine while, or after, consuming alcohol and/or drugs increases risk of bodily harm or death. No warranty or representation is made as to this product's ability to protect user from severe injury or death. Texas Tough Customs LLC urges operators and occupants to wear a helmet and appropriate riding gear at all times.

By purchasing and installing Texas Tough Customs LLC's products, user agrees that should damages occur, Texas Tough Customs LLC will not be held responsible for loss of time, use, labor fees, replacement parts, or freight charges. Texas Tough Customs LLC, nor any 3rd party, will not be held responsible for any direct, indirect, incidental, special, or consequential damages that result from any product purchased from Texas Tough Customs LLC. The total liability of seller to user for all damages, losses, and causes of action, if any, shall not exceed the total purchase price paid for the product that gave rise to the claim.

Texas Tough Customs LLC will warranty only parts provided by Texas Tough Customs LLC. Any damage or problems with OEM housings, bearings, seals, or other manufacturers' products will not be covered by Texas Tough Customs LLC. Texas Tough Customs LLC parts and products are not warrantied if item was not installed properly, misused, or modified.

Installing, adding, modifying, or fabricating any factory or aftermarket product to your ATV/UTV may violate certain local, state, and federal laws. Be advised that laws vary depending on town, city, county, state, etc. Use of certain products on public streets, roads, or highways may be in violation law. The Buyer is solely and exclusively legally and personally responsible for any violation of the law by the installation or use of the product. You must abide by all local, state, and federal laws, including but not limited to vehicle safety, traffic laws, and ordinances. It is your responsibility to know the laws and how they apply to you.

The Buyer is responsible to fully understand the capability and limitations of his/her vehicle according to manufacturer specifications, warnings and instructions and agrees to hold Texas Tough Customs LLC harmless from any damage resulting from failure to adhere to such specifications, warnings and/ or instructions. The Buyer is also responsible to obey all applicable federal, state, and local laws and ordinances when operating his/her vehicle while using this product, and the Buyer agrees to hold Texas Tough Customs LLC harmless from any violation thereof.

Stock Front Control Arms Disassembly:

Remove A-Arms: Keep all components removed from machine. Driver side shown.

- Remove Tie Rod End from Knuckle.
- Remove Axle hardware and Hub.

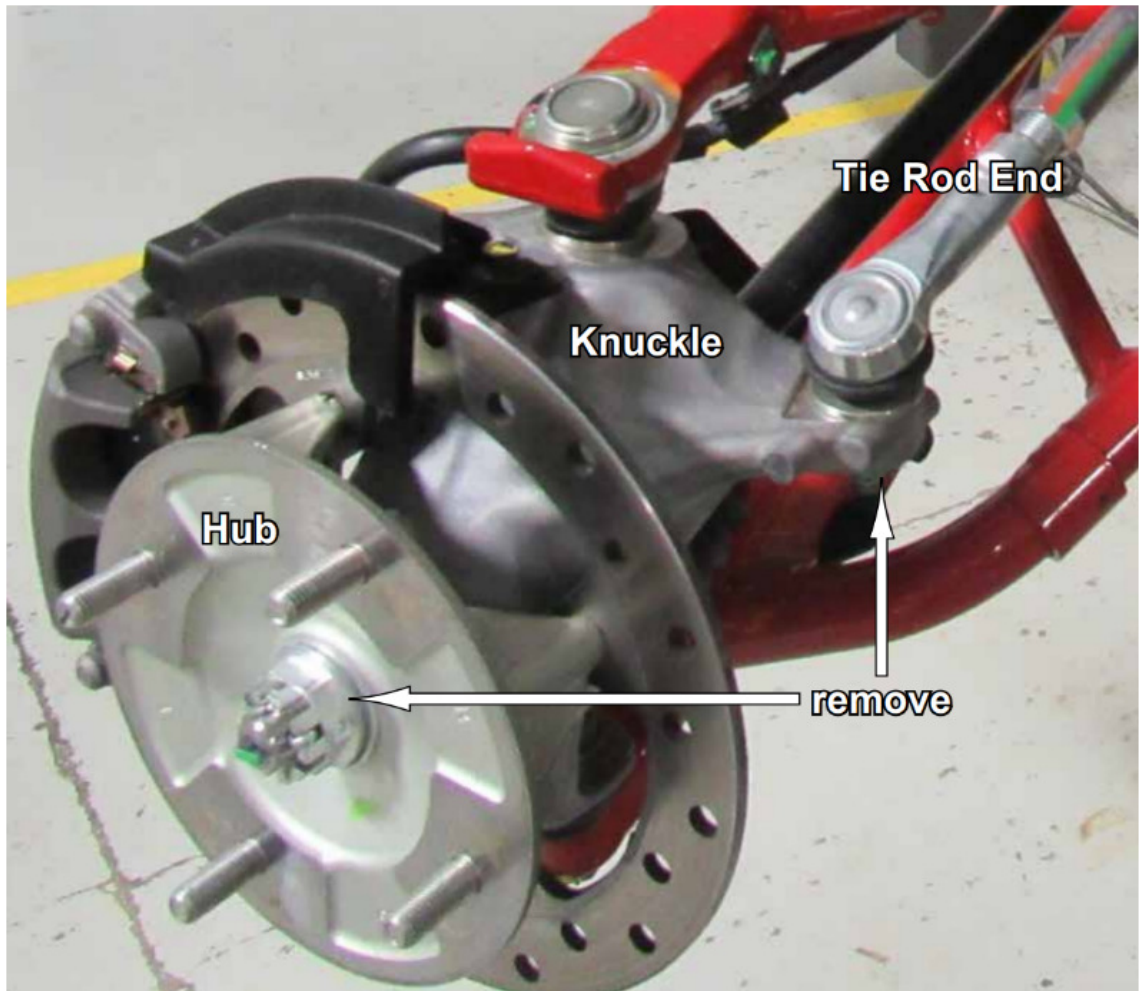

- Unfasten and remove Brake Line from Upper A-Arm.
- Remove Caliper from Knuckle.
- Remove Upper and Lower Arm from Knuckle.

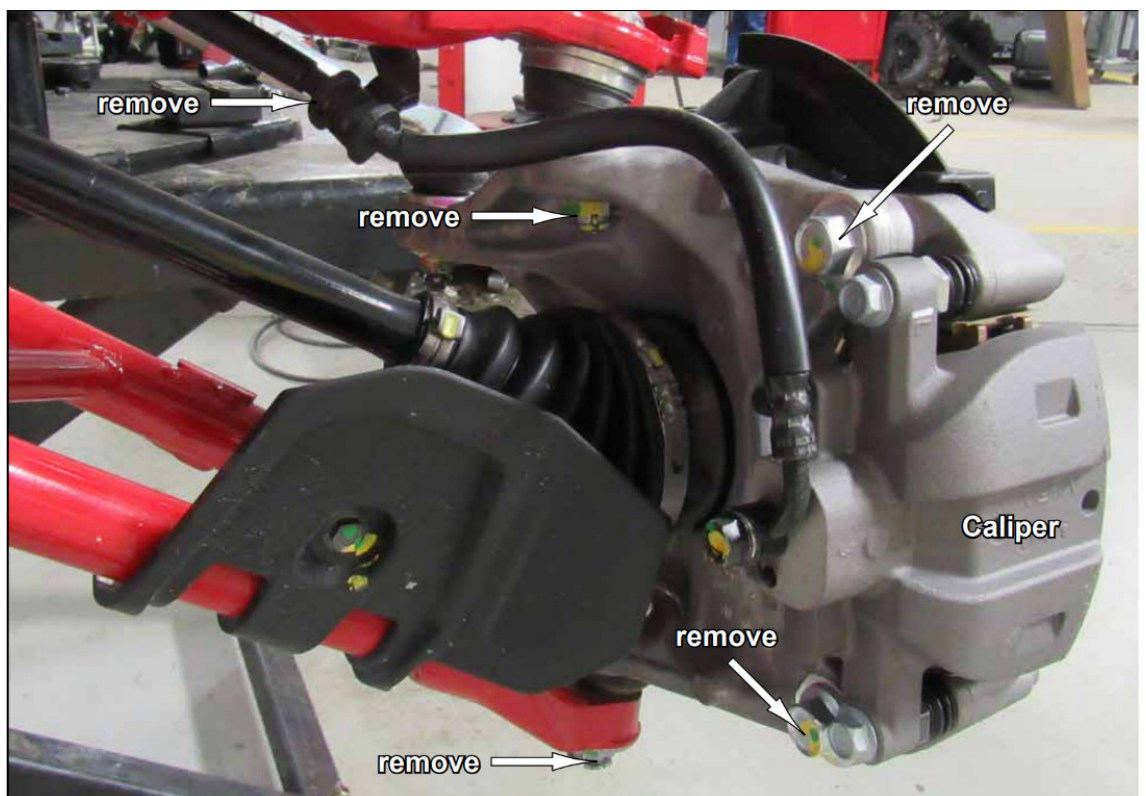

- Remove Shock from Upper Arm.
- Remove A-Arms from Frame.

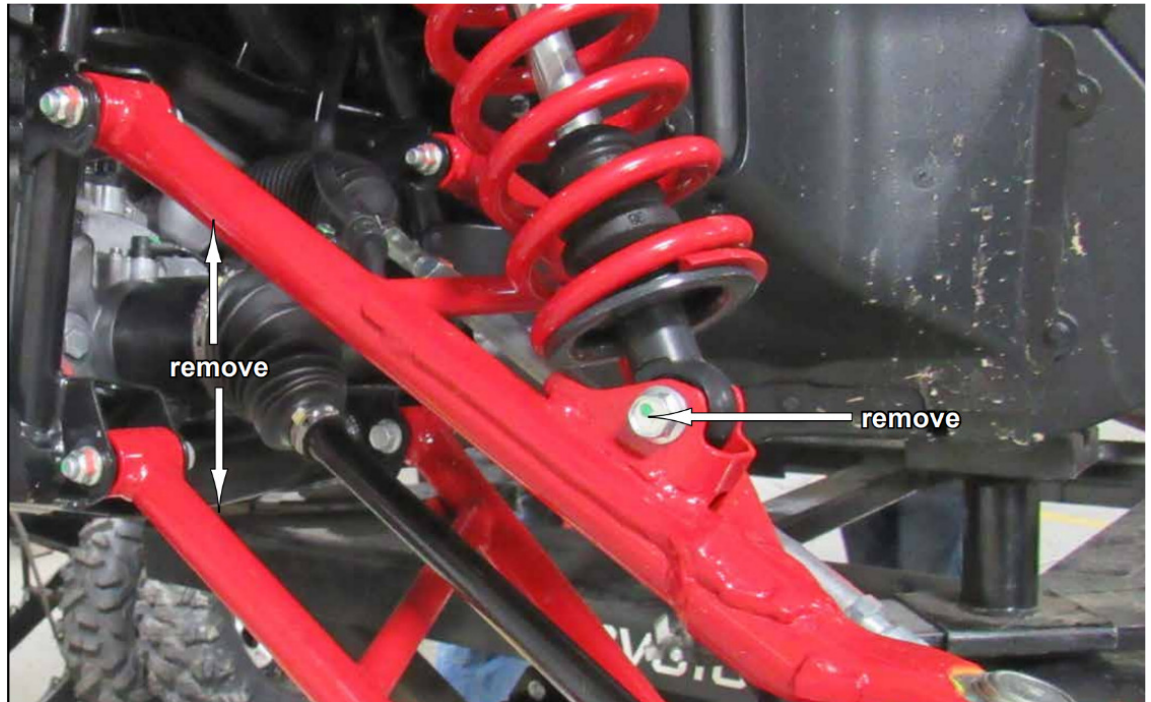

Repeat steps for Passenger Side.

TTC Talon Front Control Arms and Tie Rod Installation:

Step 1. (Assemble and Install TTC HD Tie Rods) Your new heavy-duty tie rods will maintain the use of your stock inner and outer tie rod ends (Unless you upgraded to our "Stage 2 Heim Style Tie Rods"). Disassemble the stock tie rod and remove the stock tie rod bar section. Leave the outer tie rod jam nut where it is, but screw the inner tie rod jam nut all the way on to the inner tie rod. Next, screw on our new TTC HD Tie rod to the outer tie rod end all the way down to the jam nut. Then screw the tie rod assembly onto the inner tie rod all the way up to the jam nut. This will be a pretty close place to start for the toe. Continue on with the installation and save final toe adjustment for last.



1. If you are running our **Stage 2 Heim Style Tie Rods** then you will start by completely removing the stock tie rods from the steering rack. First you will need to remove the metal clamp holding the inner boot to the steering rack. Use a flat head screw driver and a pair of wire dykes to cut the metal clamp off. Once the clamp is removed you can pull the boot back and use a crescent wrench to unscrew the inner tie rod from the steering rack. Make sure to remove the boot from the stock inner tie rod assembly and reuse in a later step. Now you can install the inner clevis to the steering rack. Make sure to use **red lock tight** on the bolt that goes into the steering rack and make sure to clock the clevis to the rear of the machine about 10 degrees. See our HSTR Install video for more info (this video is on a Pioneer, but the process is the same). Once the clevis is installed and clocked properly, install the inner heim joint into the clevis and tighten down. Next push the stock boot onto the heim and up onto the steering rack. Once the boot is all the way on, screw the jam nut onto the heim until there is .75" of threads sticking out. Now screw the TTC tie rod bar onto this inner heim all the way to the jam nut. Make sure the outer heim joint is also screwed all the way in on the outer side of the tie rod. This will be a pretty close place to start for the toe. Continue on with the installation and save final toe adjustment for last.

(If you are installing our "Stage 2" tie rods, you may need to run a 1/2" drill bit through the stock spindle to make clearance for the outer tie rod bolt).

Ideally you want to line the clevis up with the hole in the hub assembly where the outer tie rod will attach. See pic below.

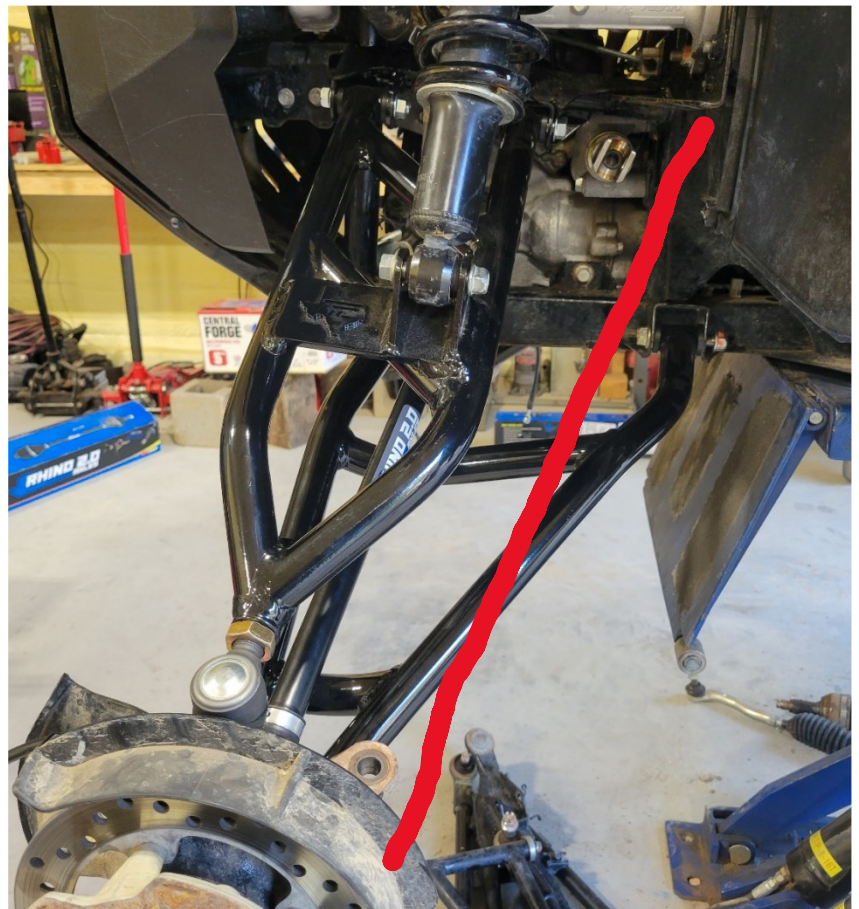

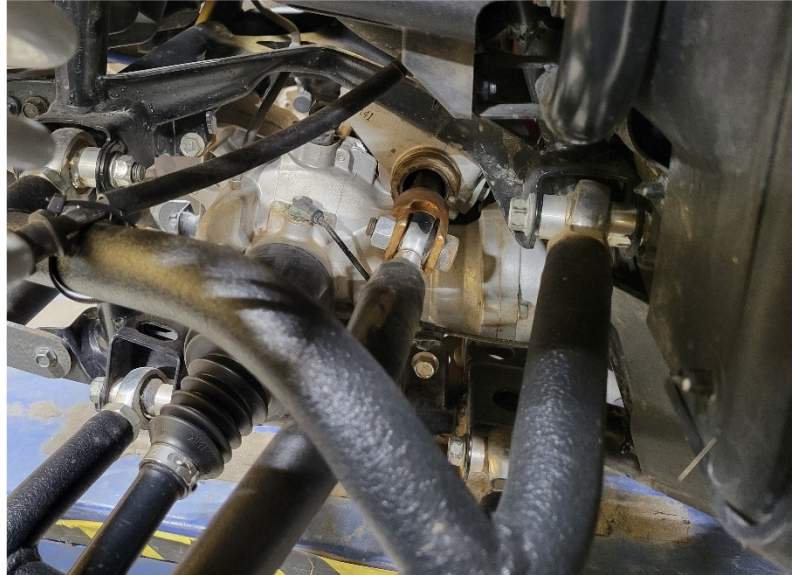

Step 2. (Install Lower TTC Control Arm) Locate the lower control arm for the side that you are working on and make sure that the ball joint is closer to the front of the machine to ensure you have the arm for the correct side. Install the lower control arm into the lower frame mount using the two factory 12mm bolts and nuts. Snug up the nut but do not tighten. **The inner heims should be screwed all the way into the arms then 4 turns out. If you are installing a “Ball Joint Delete Kit”, the 1.25” heims should be screwed all the way in then 1/2” out. (See pic below)**

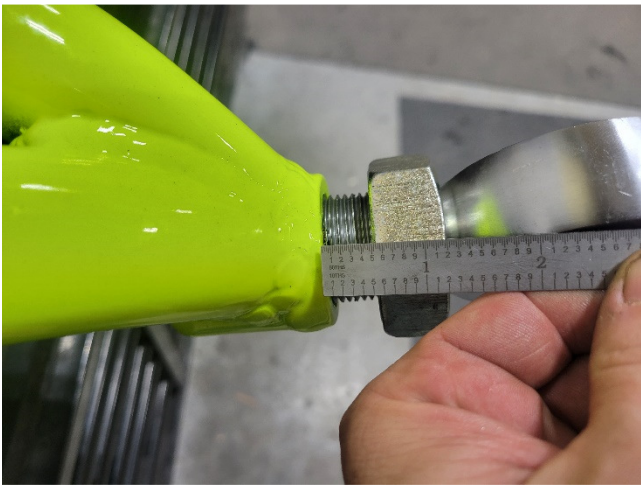

Step 3. (Install the Hub Assembly to the Lower Ball Joint)

Step 4. (Install Upper TTC Control Arm) Locate the upper control arm for the side that you are working on and make sure that the ball joint is closer to the front of the machine and the shock mount is closer to the rear of the machine. Install the TTC upper control arm into the upper frame mount using the factory mounting hardware. Snug up the nut but do not tighten. **The inner heims should be screwed all the way into the arms then 4 turns out. If you are installing a Ball Joint Delete Kit, the 1.25” heims should be screwed all the way in then 1/2” out.**

Your front upper control arms use Moog part number (ES437L) as the upper ball joints and requires the supplied spacer to be used between the castle nut and the hub assembly. *(Remember, this ball joint is LEFT HAND THREAD)*. To adjust for proper camber, **start with screwing the upper ball joint all the way in, then 2 turns out**”. Once you finish installation, you may need to adjust this upper ball joint either out or in to obtain desired camber depending on your shocks and other components.



Step 5. (Install Upper Control Arm Into the Hub Assembly) Remove the cotter pin and castle nut from the Moog upper ball joint and install it into the hub assembly. Make sure to only tighten the castle nut hand tight until front installation is complete and desired camber is achieved. Do not install cotter pin at this time.

Step 6. (Install Shock) Install the shock onto the upper control arm.

Step 7. (Tighten Frame Bolts) Once everything is assembled hand tight, go ahead and fully tighten both the upper and lower frame bolts that mount the control arms to the frame.

Repeat everything on other side....

Once both sides are complete, re-install the tires and lower the machine to the ground. Start it up and pull it forward and back while turning the wheels back and forth to allow the shocks to settle to true ride height. Once the suspension has settled back down to normal, check to see if you have achieved the desired camber (wheels are straight up and down).

If camber is correct, tighten everything down and install cotter pins into castle nuts.

Front Camber Adjustment

If the **top** of the wheel is sticking out farther than the bottom of the wheel, then you need to adjust the upper ball joint in.

If the **bottom** of the wheel is sticking out farther than the top of the wheel, then you need to adjust the upper ball joint out.

Step 1. (Remove Wheels) To adjust for camber correction, jack up the front of the machine and remove the wheels.

Step 2. (Remove Upper Ball Joint From Hub Assembly) Remove castle nut from upper ball joint and remove upper ball joint from hub assembly. Once removed, adjust the upper ball joint either in or out to achieve desired camber. *(Remember, the ball joints are **LEFT HAND THREAD**)*

Step 3. (Re-Assemble) Put the upper ball joint back into the hub assembly and secure castle nut hand tight.

Step 4. (Install wheels and Re-check Camber) Re-install wheels and start up the machine. Pull it forward and back while turning the wheels back and forth to allow the shocks to settle to true ride height. Once the suspension has settled back down to normal, check to see if you have achieved the desired camber. Repeat steps until desired camber is achieved.

Step 5. (Tighten and Finalize) Once desired camber is achieved, tighten all ball joint castle nuts and install all cotter pins.

Toe Adjustment

If your wheels are pointing **outward**, you need to **loosen** the tie rods to bring the wheels straight.

If you wheel are pointing **inward**, you need to **tighten** the tie rods to bring the wheels straight.

Step 1. (Adjust Toe) Make sure all tie rods are screwed all the way in and the jam nuts are loose. Since one end of your tie rods are right hand thread and the other is left hand thread, this allows you to grab the HD tie rod itself and either tighten or loosen it to obtain desired toe adjustment, but it may be easier to remove outer tie rod from the hub assembly and adjust the outer tie rod itself. Check toe by measuring the distance between the wheels in front of the ball joint and comparing it to the distance between the wheels behind the ball joint.

Step 2. (Tighten) Once desired toe is reached, tighten the jam nuts and make sure to check them frequently.

TTC R Rear Control Arms Installation: (Slight Modification Required)

Remove Stock Upper and Lower Control arms and maintain all stock hardware.

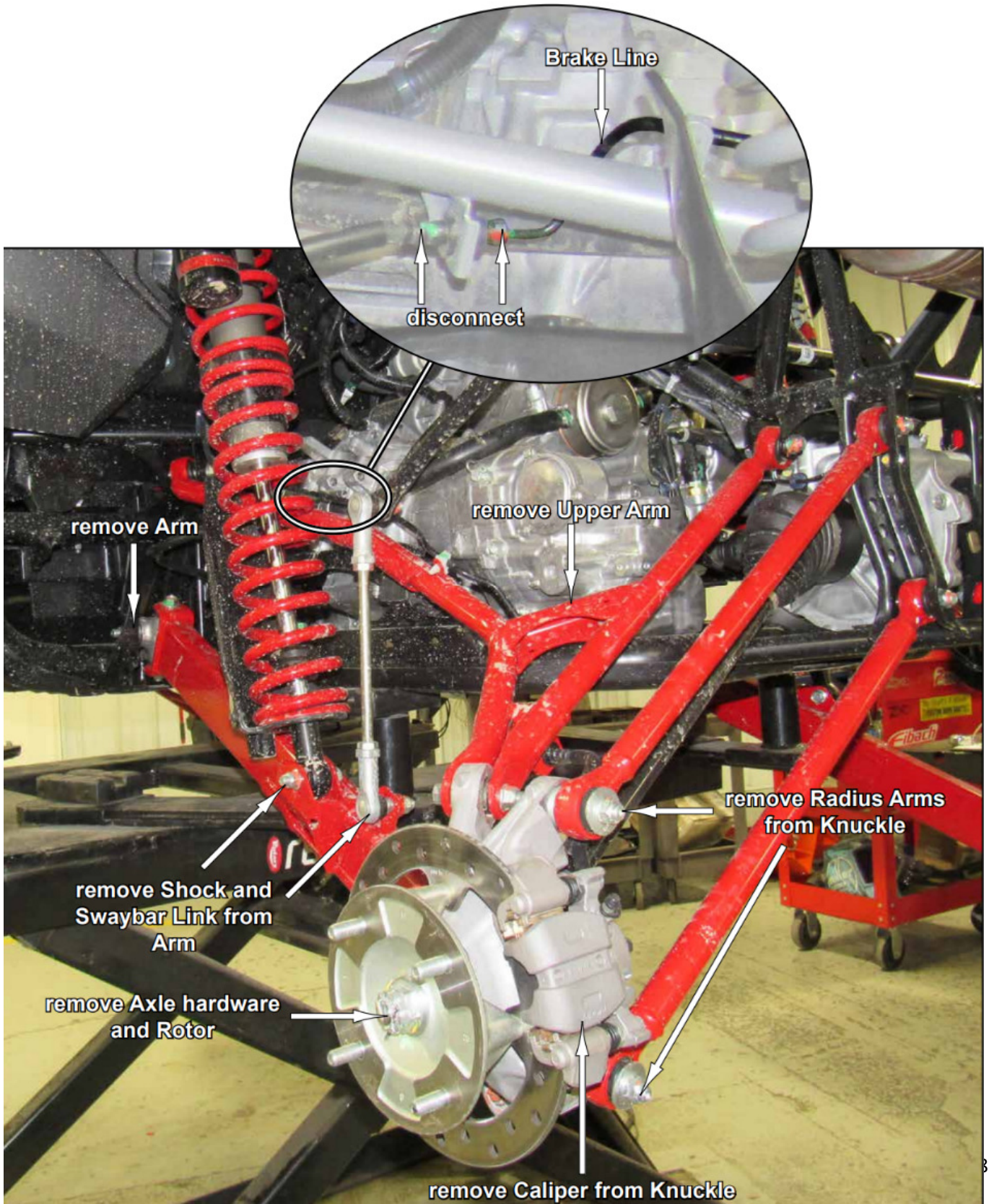

Once the stock arms are removed you will need to modify the lower ball joint hole on the rear hub assembly so that the new TTC ball joint can be installed. To do so you will also need to remove the axle nut, brake caliper, and rotor.

Using a 5/8" drill bit, drill out the lower ball joint hole from the outside. It will only remove a very small amount of material and will still work with the stock ball joint in case you need to return to stock.

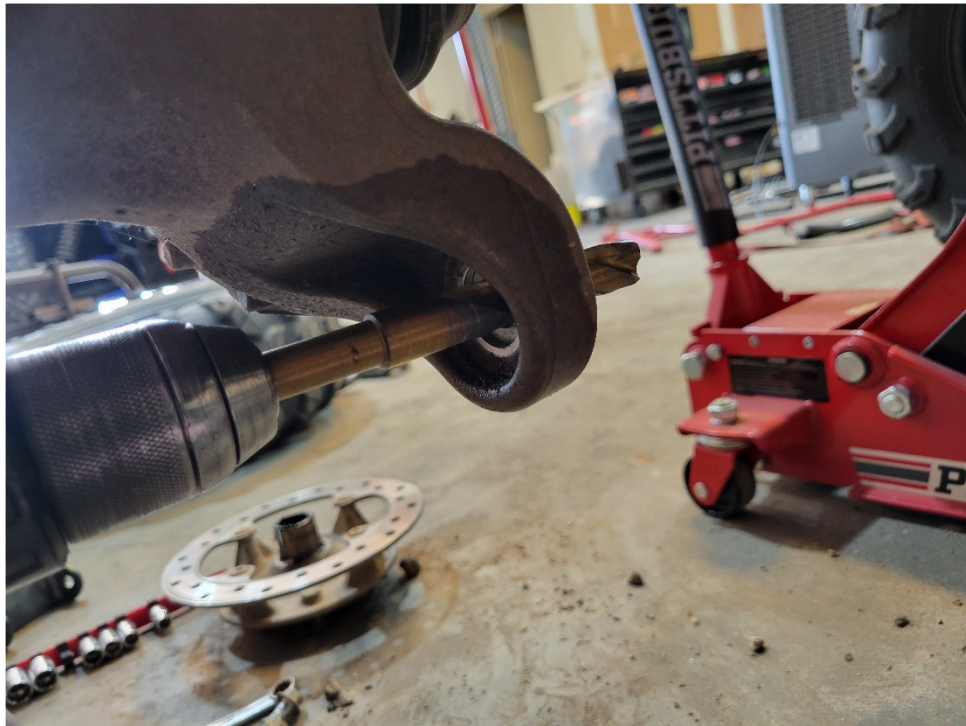

Once the rear hub assembly has been modified the new ball joint will install perfectly.



Using the stock hardware, reinstall your new TTC Arms back on the machine and repeat on other side.

Secure stock brake lines to upper arm with zip ties making sure the brake lines are not rubbing on other components.



TTC Talon R Radius Rod Installation:

Remove Stock radius rods and maintain all mounting hardware.

Use the photo below to set your new TTC Radius rods to the proper length before installation.

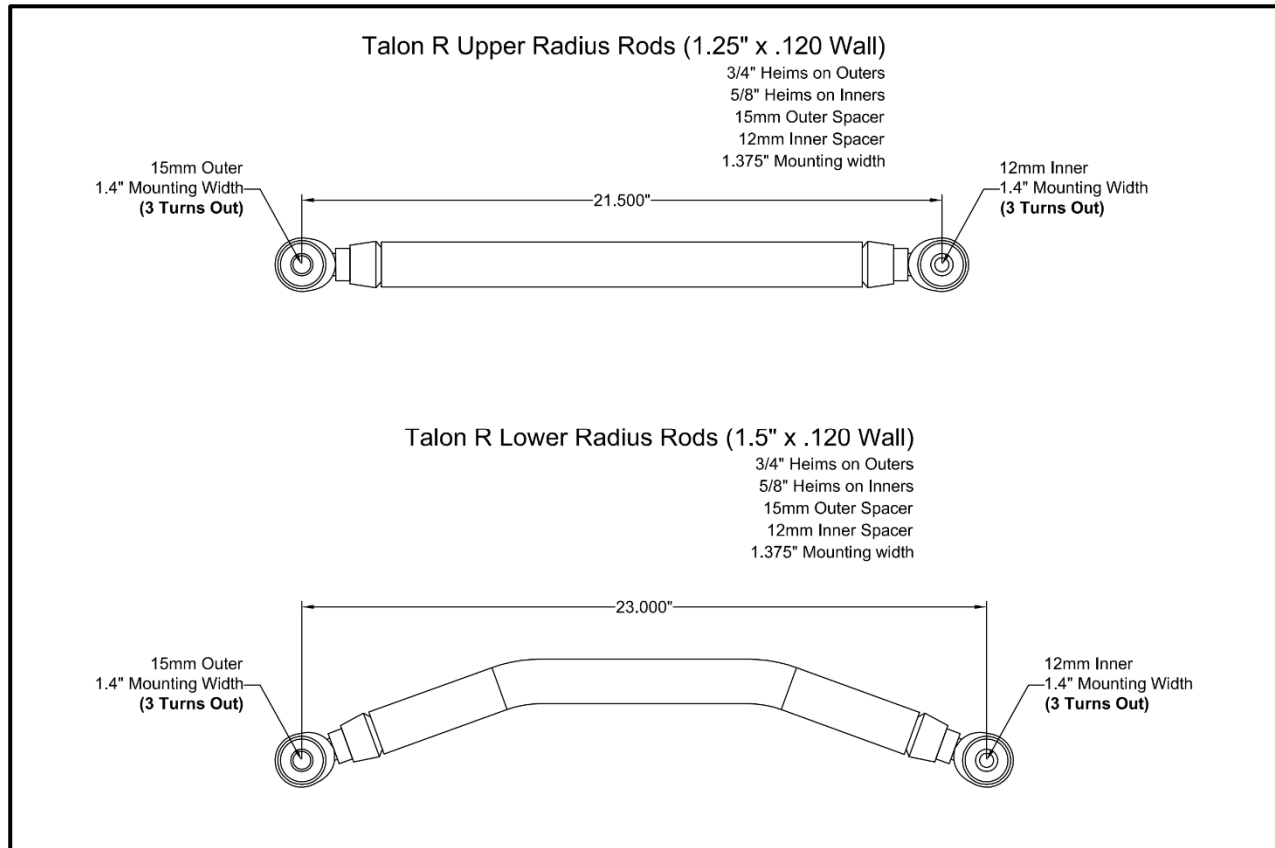

Once eye to eye dimensions are confirmed, install TTC Radius Rods onto the machine, using all factory mounting hardware.

Once installed, pull the machine forward and back to allow the suspension to settle to true ride height then double check that the rear camber and toe is where you want it. Fine tune adjustment may be necessary.

Don't hesitate to give us a call if you have any question during your installation. 936-581-2948